

SERVICE REFERENCE BOOK

of the MASTER TECHNICIANS SERVICE CONFERENCE

SESSION NO.

125

Brake Service

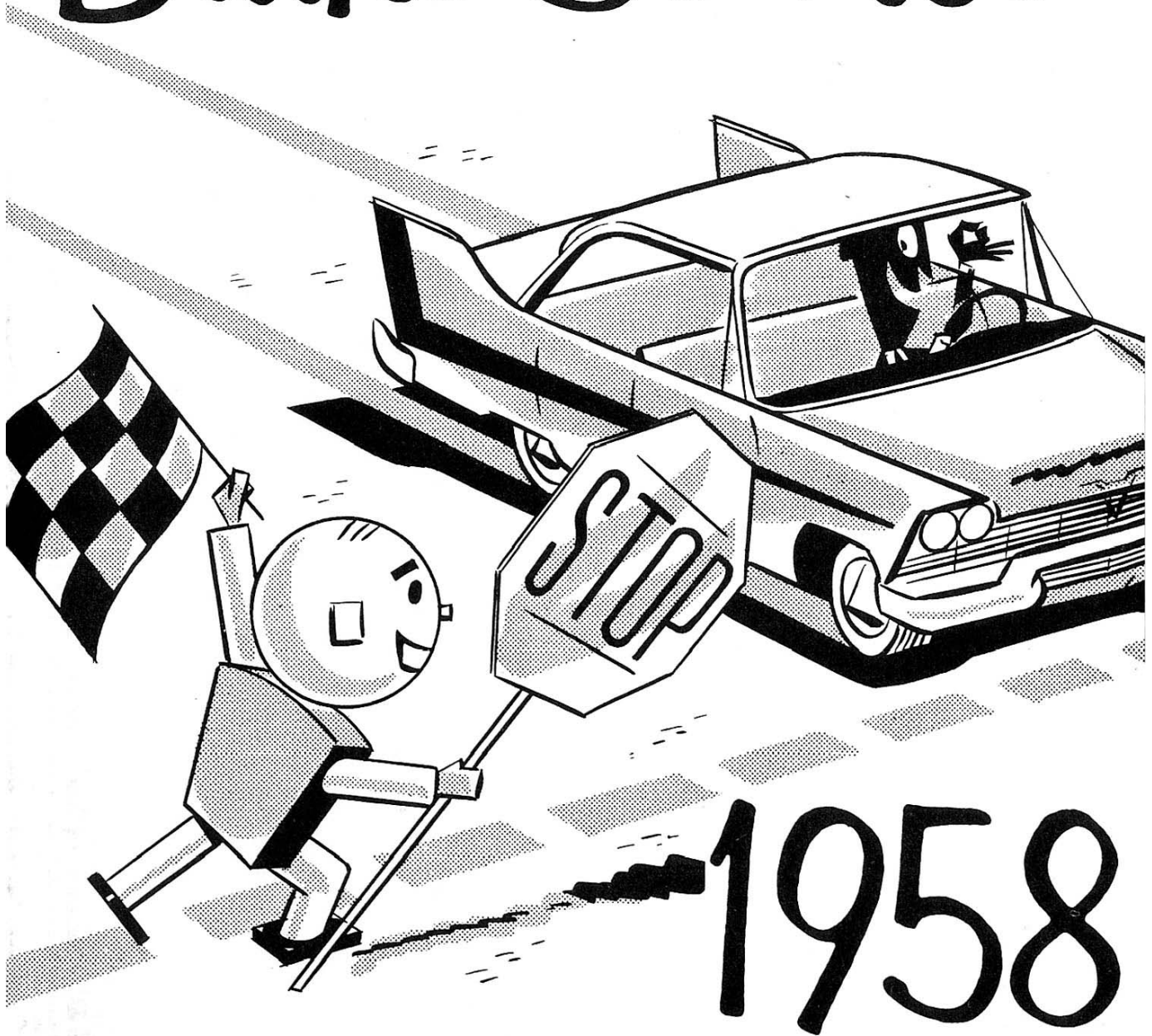

PREPARED BY CHRYSLER CORPORATION
Plymouth • Dodge • De Soto • Chrysler • Imperial

Tech sez:

**“GIVE BRAKE SERVICE
YOUR BEST ATTENTION!”**

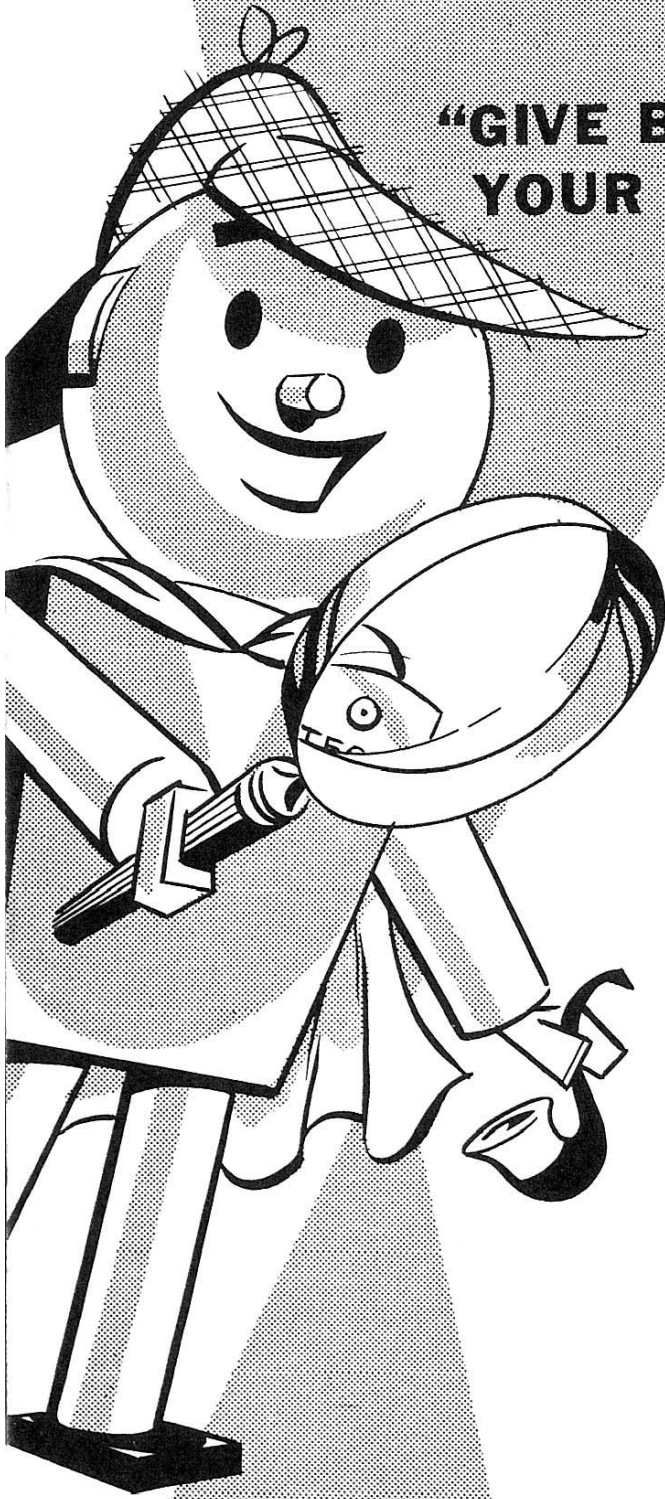

Let's face it. Brakes are one of the most important car controls. So brakes certainly deserve the best you've got in materials and service attention.

Once your owners know that you're up on all that's needed to keep brakes performing safely, your service department will earn their deepest respect and confidence. That's why this reference book goes into the various conditions which affect brake performance, and what to do when brakes need attention.

Here's where you'll find brake service suggestions you ought to know:

	Page No.
BRAKES HAVE AN IMPORTANT JOB	3
CAUSES OF PULL, NOISE AND FADE	4
Brake Pull—Basic Principles	5
Brake Noise—Basic Principles	5
Brake Fade—Basic Principles	6
MAINTENANCE	8
DIAGNOSIS AND CORRECTION	8
Road Test	8
Causes of Pull	9
Causes of Noise	20
ADJUSTING POWER BRAKES	21
Free-Play	21
Trigger Adjustment (on car)	21
Trigger Adjustment (on bench)	22
Power Booster Air Noise	23
FOR SAFETY'S SAKE, REMEMBER THIS	23

BRAKES HAVE AN IMPORTANT JOB

Brakes do a tremendous job today. Cars are heavier and go faster than ever. Because of these higher car speeds, brakes have to do more work than they ever did. Automatic transmissions, reduced cooling resulting from smaller wheels, and front-end sheet metal design also add to the extra work brakes have to perform.

Here's one interesting comparison. It takes almost 300 horsepower to *accelerate* a car weighing nearly two tons from 0 to 60 m.p.h. in about 10 seconds.

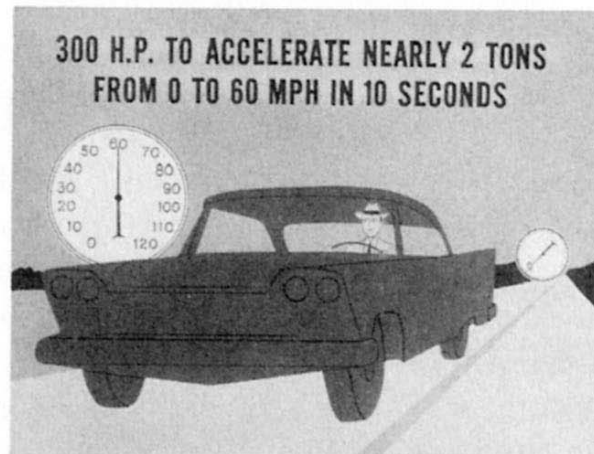

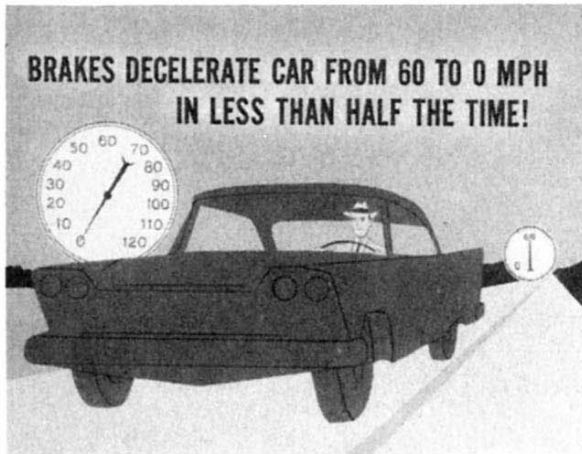
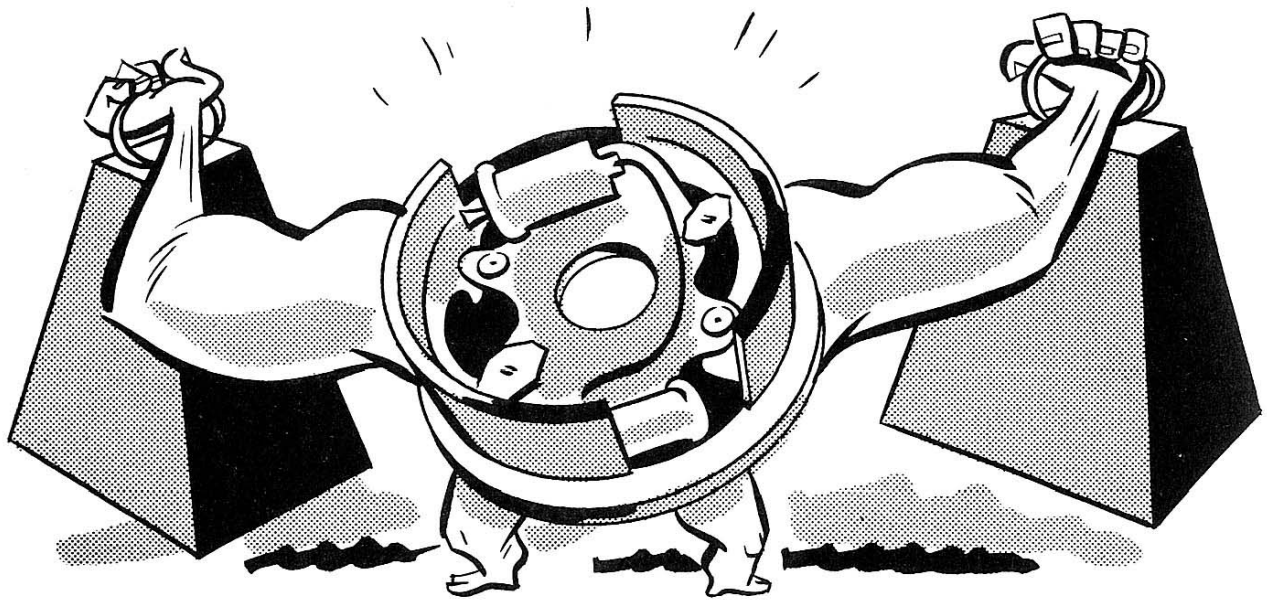

On the other hand, we expect brakes to *decelerate* the same car from 60 to 0 m.p.h. in something *less than half the time!* So, in terms of power, brakes *stop* the car *better* than the engine makes it go.

Said another way, when you work on brakes, you're taking care of $2\frac{1}{2}$ times as much power as a man working on the engine. For safety's sake, that margin of brake power must be maintained.

CAUSES OF PULL, NOISE, AND FADE

Before you can diagnose and correct a case of brakes *pulling* to one side . . . *noisy* brakes, or brake *fade*, it pays to know what causes these conditions. Not knowing the cause might lead you to believe that merely readjusting the brakes would take care of the difficulty. Shoe adjustment, of course, is mighty important, but it is often only one of the steps required. If an adjustment is all you do, you'll probably see the car back again for "do-over" work at no charge.

Brake Pull—Basic Principles. On a case of brake *pull*, which is caused by *uneven braking effort* (more on one side of the car than the other), it's quite easy to make the wrong diagnosis. As an example, if a car pulls to the *left*, don't jump to the conclusion that there's *too much* braking effort on the *left* side. On the contrary, pulling to the left could be caused by *too little* braking effort on the *right* side of the car!

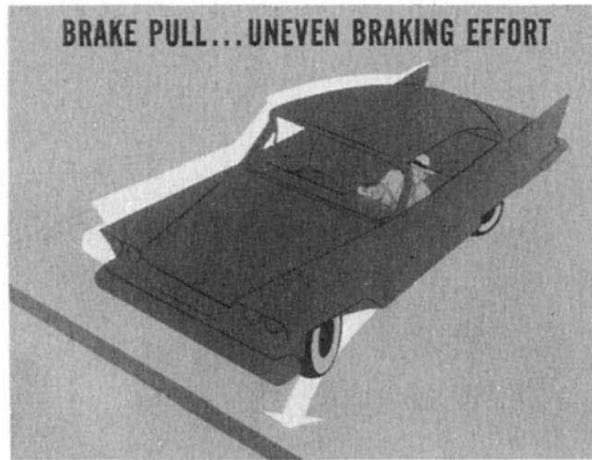

Sometimes a pull to one side isn't even caused by a *brake* condition! Instead, it happens because of an error in front end alignment. The effect of suspension on braking has often been overlooked. Any car that drifts away from straight-ahead during normal driving, and pulls in the *same* direction when brakes are applied, probably has an *alignment* rather than a brake condition. Obviously, all the work you may do on brakes can't possibly correct a suspension fault. So, keep suspension in mind when you check a brake condition.

Brake Noise—Basic Principles. As far as brake *noise* is concerned, remember that all sounds are the result of *movement*, or *vibration*. The brake drum, for instance, can act a lot like a bell. Strike the side of it as a clapper strikes a bell, and you'll hear it ring out. But you know that if you held the rim of a bell (or the drum) firmly before the clapper strikes it, it would deaden the sound.

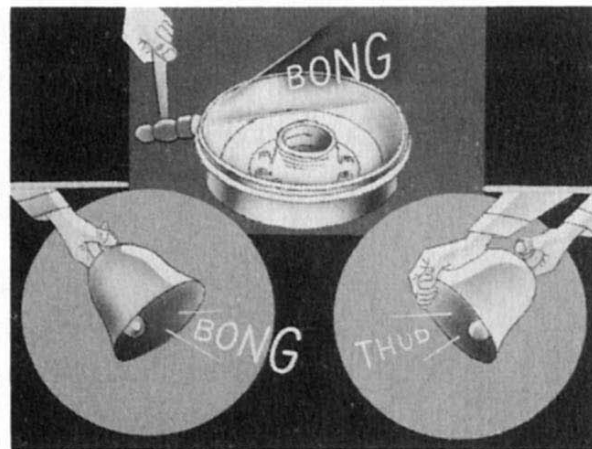

So, when you check the brake assembly and related suspension and steering parts, be sure everything is up to torque and clearance

specifications. Too much play anywhere can cause vibration, resulting in noise. Properly tightened and adjusted parts will do a lot to prevent noise. Other factors enter the noise picture, but vibration is the source of noise.

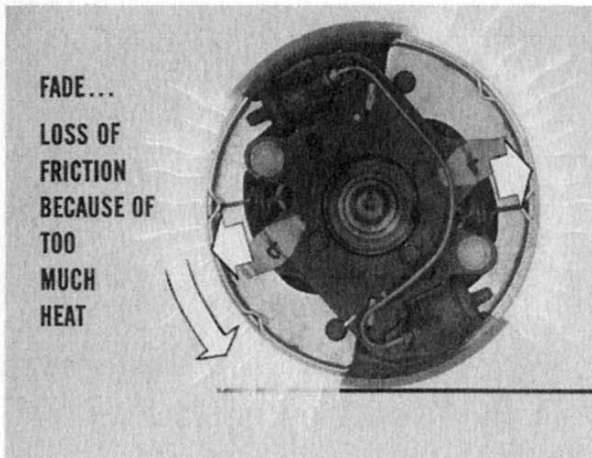

Brake Fade—Basic Principles.

The main cause of *fade* is a *loss of friction* between the lining and drum because of too much heat. Heat changes the friction characteristics of brake lining. As temperature rises, the lining loses some of its ability to grip the brake drum and stop the car.



When the lining loses gripping ability, the driver has to step harder on the brake pedal to force the shoes tighter against the drums. This increases heat even more, and there's a greater loss of friction.

Added pressure still won't produce more braking power if the lining gets so hot that it loses most of its friction. And that's what we mean when we talk about lining "fade".

Here's something else. When too much heat causes the drums to expand . . . the shoes have to reach out farther to touch the drum. More brake fluid has to be displaced and pedal travel increases.

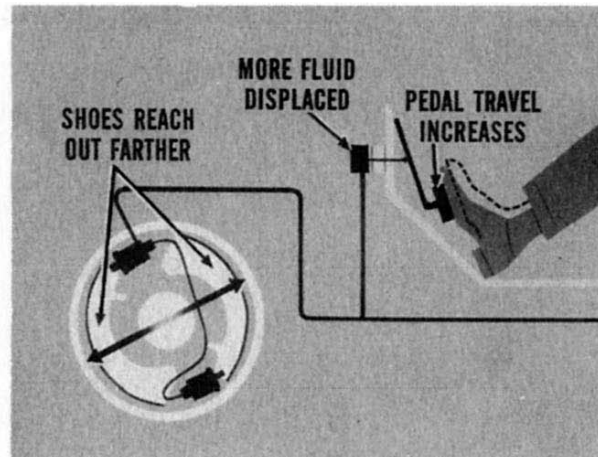

Pedal travel also increases because of mechanical deflections caused by extreme pedal effort. In addition, too much shoe clearance . . . low fluid level . . . the wrong type of fluid . . . air in the system due to improper bleeding . . . a leaking master cylinder check valve—all can cause increased pedal travel.

Loss of friction due to heat, incidentally, is typical of the linings that all cars use. There's bound to be some fade under unusually severe braking conditions even when everything's up to snuff. As technicians, our job is to work carefully and properly to control fade. That way our brakes will operate well under all normal conditions, with an ample margin of safety.

Naturally, other factors must be checked when you have a fade condition. All brake parts, for instance, have to be right so maximum lining contact is maintained. If there's *less than full contact*, it will result in hot spots and a more severe loss of friction. There'll be increased pedal effort, and reduced stopping ability for even normal driving conditions.

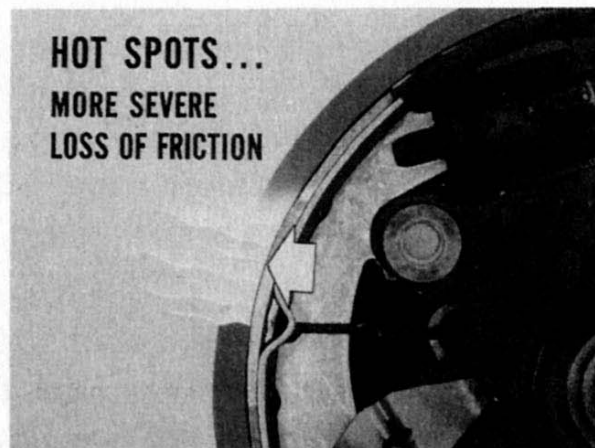

Not only that, uneven friction that results from less than full con-

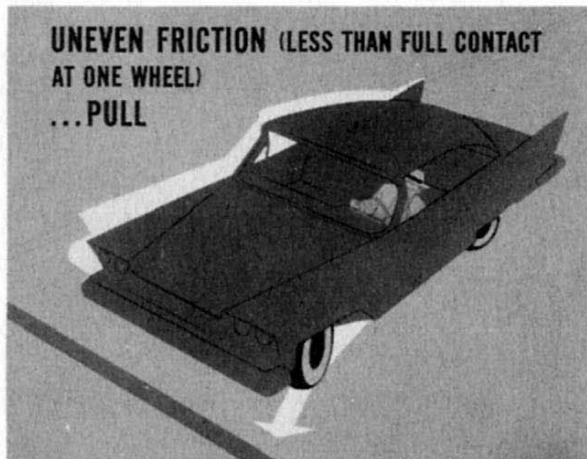

tact at *one* wheel can cause a bad case of *pull* to the opposite side. In short, there are times when brakes have a combination of fade and pull. So, correcting causes of fade often corrects many causes of pull. Correcting causes of pull often takes care of a fade condition—especially if there’s any tendency toward brake *drag*.

MAINTENANCE

Diagnosis and Correction

Road Test. With any brake condition, always road-test the car first. Whenever possible, it’s smart to road-test the car with the owner. Let *him* drive the way he usually does, and over the same type of roads he generally travels. That’s how you’ll get the most accurate picture of the type of brake condition he’s asking you to correct. Following this, you drive the car. Try to bring in the same conditions he’s pointed out, and double-check your own impression of the trouble. Try the brakes at slow, medium, and high speeds. See if the car makes a straight-line stop, pulls to one side, or if the brakes tend to fade.

CAUTION: Avoid making successive high-speed, panic stops on *new linings*. Linings, like other parts, have to be “worn in” carefully until they make full contact. Some fellows may think they can “burn in” new linings, but they’re dead wrong. This can lead to serious brake trouble.

Check brake pedal effort, pedal travel, and “feel”, to make sure that the hydraulic system is working properly. During your road test, check the action of the shock absorbers. A defective shock can cause brake pull.

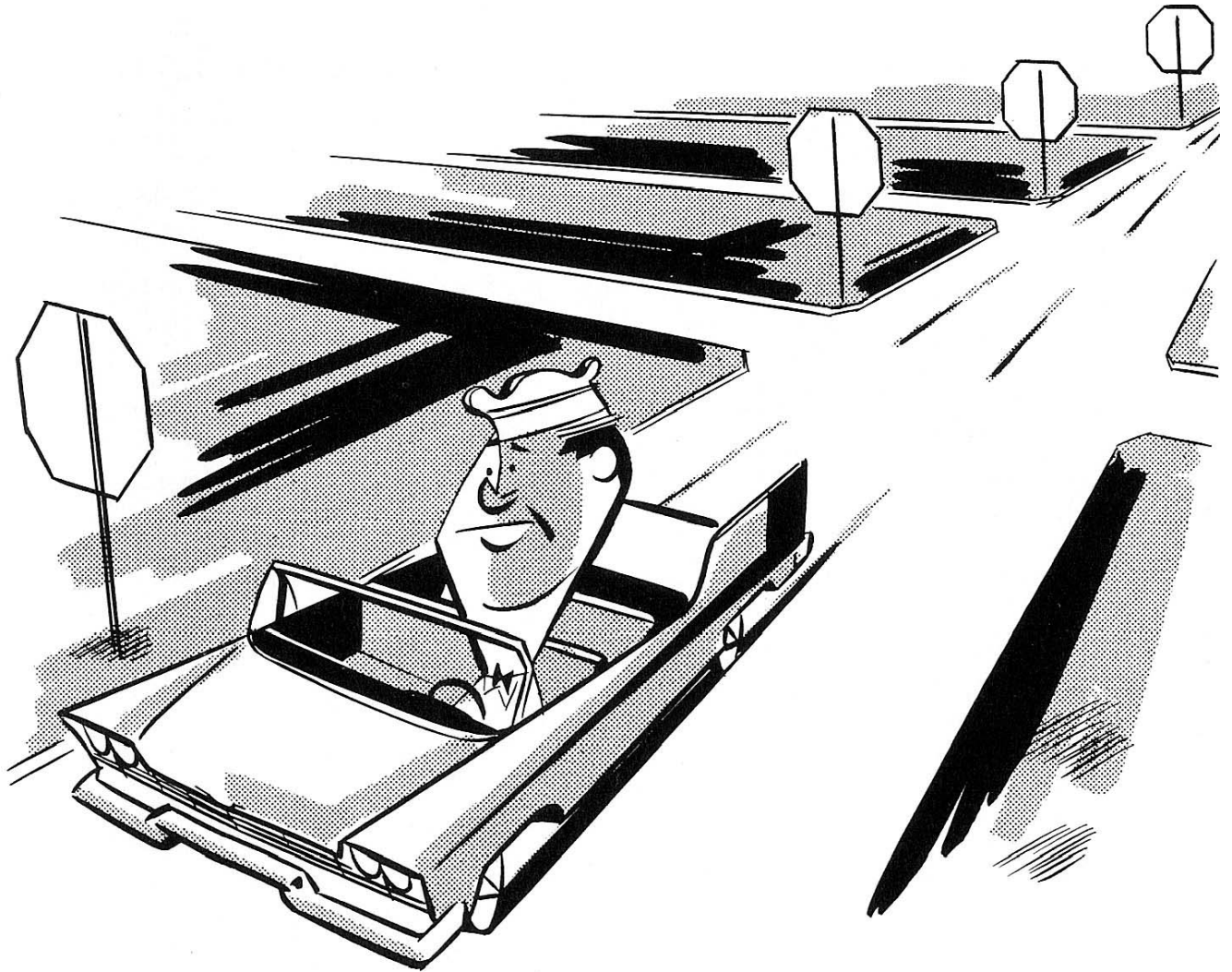

If the owner reported that the brakes *pulled* on application, observe how the car *tracks*. If the car *wanders*, or tries to *lead* in the *same direction* as the brakes tend to *pull*, there are a number of points you'll have to check.

Causes of "Pull". Pulling to one side when brakes are applied is probably the condition most frequently reported by owners. And, since some of the causes of this condition also contribute to "lining fade", let's examine those causes.

As you know, brakes are designed in relation to the entire car. So, what *seems* to be a brake condition can actually be trouble somewhere else. Effective braking depends not only upon good brakes, but also upon the suspension system that transfers braking action to the road.

In other words, if connections between the wheels and the rest of the car are loose, worn, or misaligned, brake action will be erratic. Brakes may be noisy, pull to one side on application, or both. If your road test shows that they pull to one side, here are the things to check.

First, examine the tires. An under-inflated tire, or a smooth tire opposite one with good tread can cause uneven braking. While you're checking that, check wheel bearing adjustment.

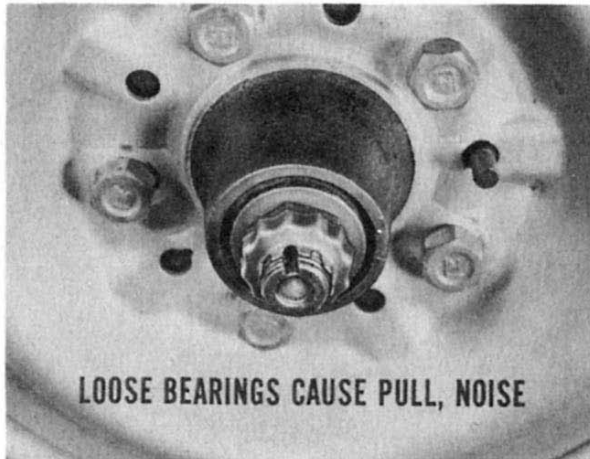

Loose wheel bearings in themselves can cause pull. They will also cause noise. So be sure they are adjusted properly before you go any farther in checking front-end alignment.

All 1958 models using the new wheel spindle nut lock should have the wheel bearings adjusted by using a torque wrench. Tighten the bearing adjusting nut to 90 inch-pounds torque. Remove the wrench and install the nut lock over the nut, with the cotter pin hole in the spindle in line with one set of slots in the nut lock. Back the nut lock and adjusting nut (moving both at the same time) off until the cotter pin hole lines up with the next set of slots. Then install the cotter pin.

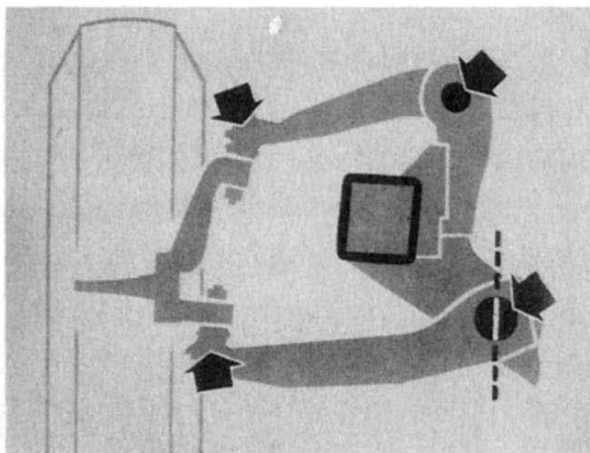

Next, check the upper and lower control arms. See that there is no excessive looseness at the inner bushings and ball joints. Also, check for steering linkage looseness—especially at the tie rod ends and at the idler arm bushing.

Pick up a torque wrench and get a reading on the lower control arm strut attaching bolts. These should be tightened to 65 foot-pounds. The strut nut at the front end should be torqued at 30 to 35 foot-pounds. This strut, as you know, keeps the lower control arm in line and soaks up the major part of the braking force.

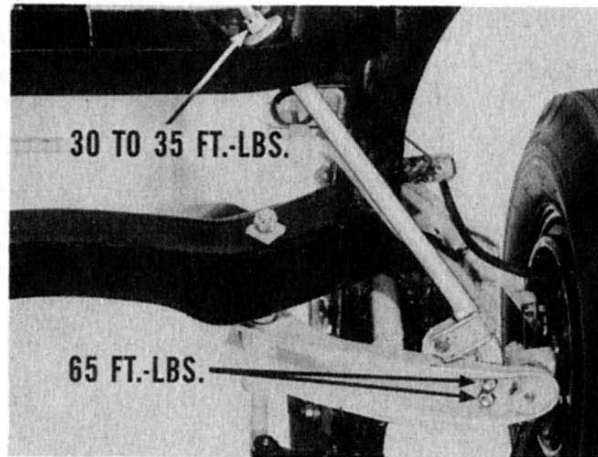

Check suspension level next. If this is okay, then check caster, camber, and toe-in. All should be up to specifications for the car you're working on. Each one plays an important part in effective braking.

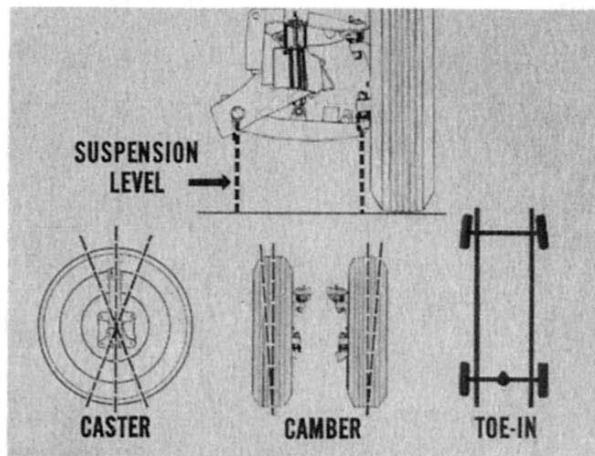

Manual steering cars should have *negative* caster. This reduces steering effort at low speeds. Power steering cars should have *positive* caster. This gives better directional stability, and improves wheel returnability on turns.

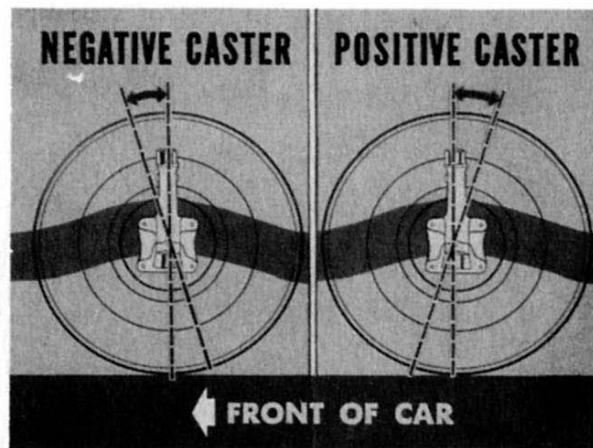

In any event, make sure caster is the *same* on both front wheels. Positive caster on one side, and negative on the other will cause a pull toward the side with negative caster when the brakes are applied.

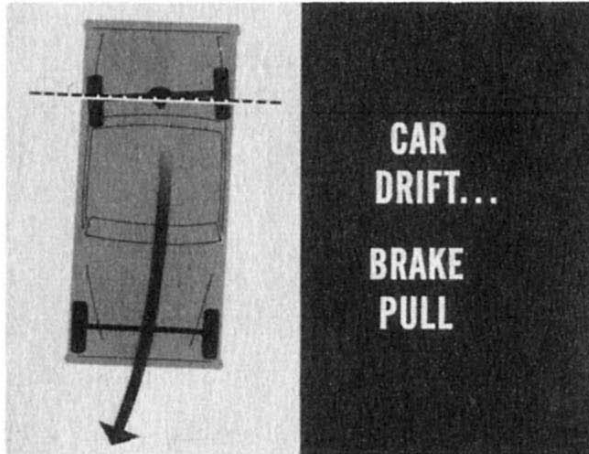

Don't overlook the rear suspension either! Rear axle U-bolts should be tightened to 70 foot-pounds torque, or the axle housing will shift on the springs. Misalignment here can cause the car to drift during normal driving, and pull to one side on brake application. Loose U-bolts can also be a cause of rear brake howl.

Another cause of pulling to one side when brakes are applied is dragging brake shoes. Dragging shoes heat up and cause loss of friction. Then, when brakes are applied, the car will pull toward the side on which the shoes do not drag.

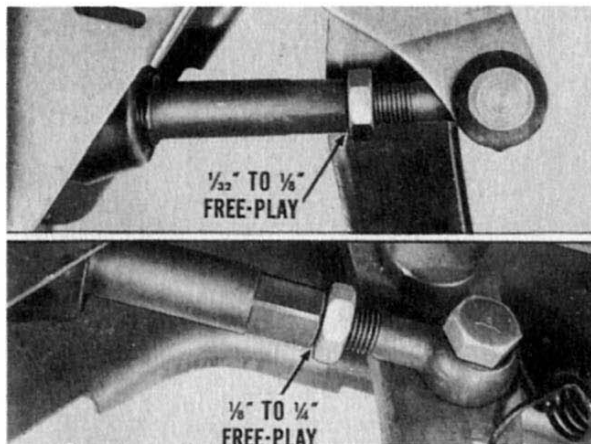

So, check pedal free-play first. No free-play can cause brake drag. On power brake installations, adjust the master cylinder push rod to get $\frac{1}{32}$ " to $\frac{1}{8}$ " free-play, with $\frac{1}{16}$ " preferred. On standard brake jobs, free-play should be $\frac{1}{8}$ " to $\frac{1}{4}$ ", with $\frac{1}{8}$ " preferred.

NOTE: On some models of later production “L” series cars, manual brakes have a built-in free-play at the master cylinder push rod. On these cars, then, no adjustment is necessary.

If pedal free-play is within standard, raise the car and spin the wheels, listening for dragging brake shoes. If you hear the shoes dragging, remove the drums and check for the cause.

Now, suppose pedal free-play, wheel alignment and front suspension are within standard, and yet the car pulls to one side on brake application. In a case like this, remove the drums and check the brake shoe push rod positions. Push rods should seat firmly in their slots. A burr or weld flash on the web can make the push rod hang up.

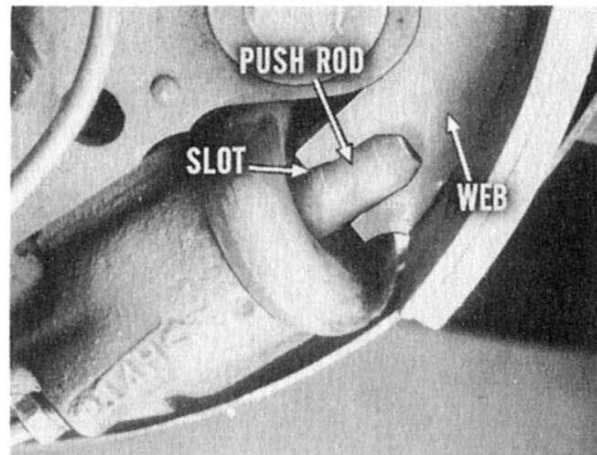

Check lining wear pattern next. It should be even over the full width and length of the shoe. Heavy heel or toe contact can cause noise, or even brake lock-up! Linings are ground undersize initially to avoid heavy heel and toe contact. However, they reach a full contact pattern after 400 to 600 miles of service. Approved linings are ground .010” to .024” under drum diameter. Occasionally, somebody might try to grind more than .024” under as a cure for noise. That should never be done. It not only won’t do any good, it will reduce lining contact area. This causes hot spots, which result in more fade and less braking.



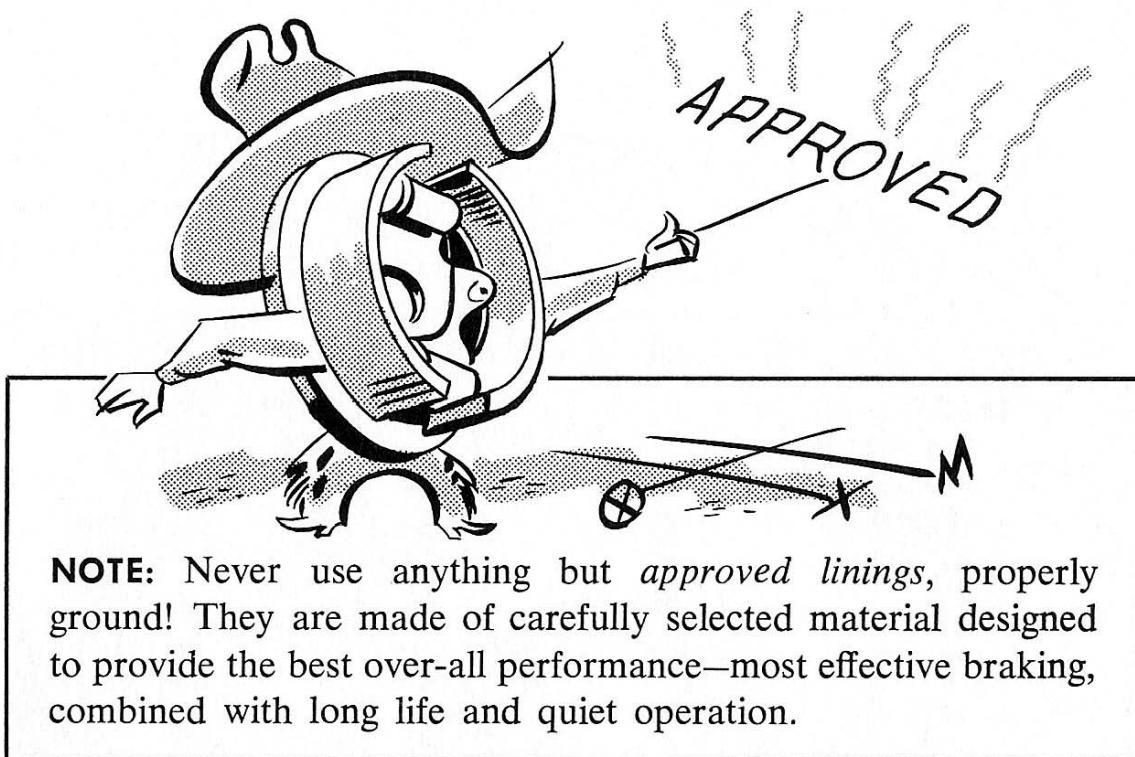

With a brake shoe adjusting gauge (DD-1168) check to see if the brake shoe is making full-surface contact with the drum across the face of the lining. If there is any variation, the maximum gap should be toward the outer edge, and must not exceed .010".

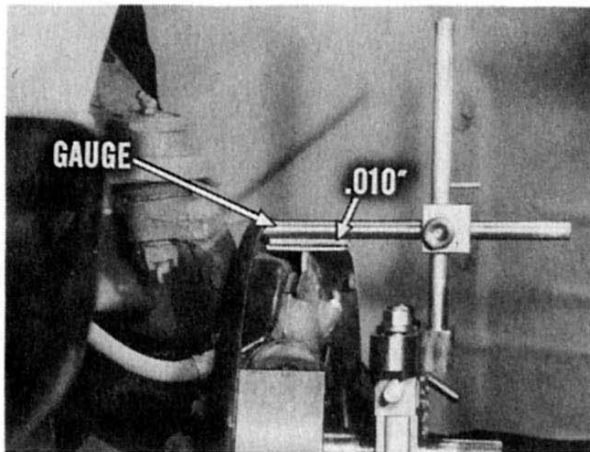

If the shoe isn't square, the table might not be at right angles to the web. Also, the shield and support plate could be out of line, or the shoe loops might not be making proper contact with the shield. You'll have to determine the cause, and make whatever service correction is necessary.

Next, check the brake drums for burnt spots or roughness (chatter marks, threading, and cracks). Replace drums with burnt spots or cracks. You can polish out roughness and threading on a drum lathe by rubbing 60 or 80 grit emery cloth over the braking surface for about four minutes. Finish up by polishing with 200 grit (or finer) emery cloth for at least 30 seconds. Polishing out roughness or contamination on the braking surfaces also helps to prevent noise.

If the drums cannot be cleaned up by hand, and you find it necessary to turn drums on a lathe, be sure to remove equal amounts of material from drums on both sides of the car. Never remove more than .030" from any drum. And, if you do turn the drums, remember that the linings must be ground .010" to .024" under the new diameter.

If linings are contaminated by grease, fluid, water, or dirt, correct the cause of contamination before replacing the linings. Replace leaking grease seals or leaking wheel cylinders. Use heavy body sealer between the dust shield and the front wheel cylinders to keep road splash out.

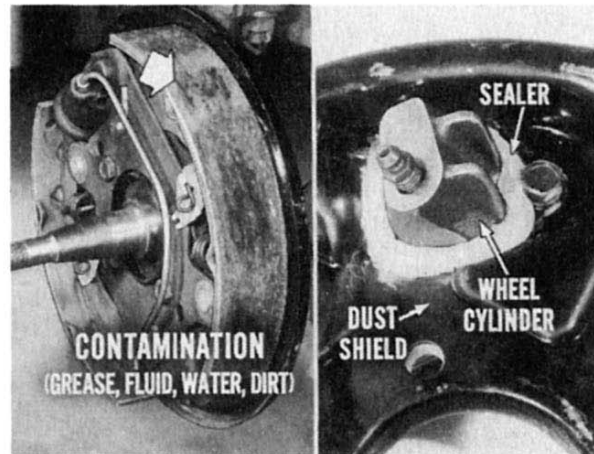

NOTE: Slight dampness on the wheel cylinder may not mean there's a leak. Swabbing fluid, used to facilitate assembly of wheel cylinder parts, may sometimes be mistaken for a brake fluid leak, especially on new cars. Check the master cylinder reservoir to see if there has been an actual loss of fluid.

CAUTION: When replacing shoes, use only approved replacement shoe assemblies. The web is made of alloy steel, properly heat-treated, and especially machined at the heel to prevent distortion where the web contacts the anchor. Non-genuine shoes without these features are *dangerous!* Non-genuine linings are equally risky.

If you use locally bonded exchange shoes, or rebond them yourself, use only Chrysler-approved equipment to burn off old lining. Excessive heat will draw hardness from the heel end of the web, and that may cause trouble later.

Slow brake shoe return can also cause brake drag, resulting in drift. Check for this by removing the drums and carefully applying the brake pedal to expand the shoes slightly. Note how fast shoes return when the pedal is released. Be careful not to push cups and pistons out of the cylinders.



If shoe return *is* slow, inspect master cylinder cups for swelling caused by contaminated fluid. Inspect wheel cylinder cups for the same fault. Replace any swollen cups, flush the system with alcohol, and refill with only the recommended brake fluid.

NOTE: Always use only approved brake fluid. It's designed to contain the right amount of lubricant, rust inhibitor, and has a high boiling point. All are important for proper brake operation.

Incidentally, kinked or plugged lines are another possible cause of shoe drag. Be sure to check this item, too.

When disassembling wheel cylinders, keep a sharp eye out for expanders in the piston cups. Some models use them, some don't. If you find expanders, be sure to reinstall them and their springs as it means there are expanders and springs in wheel cylinders on the opposite side of the car. Expanders left out on one side may cause unequal brake action.

In a case of loss of pedal (pedal goes to floor), first check brake shoe adjustment. Next, check the hydraulic system for leaks. Also, check the master cylinder cups for scoring. If the primary cup is cut, check the master cylinder compensating hole for burrs or sharp edges. Hone the master cylinder and install a new piston, cup and valve. Finally, bleed the brake system.

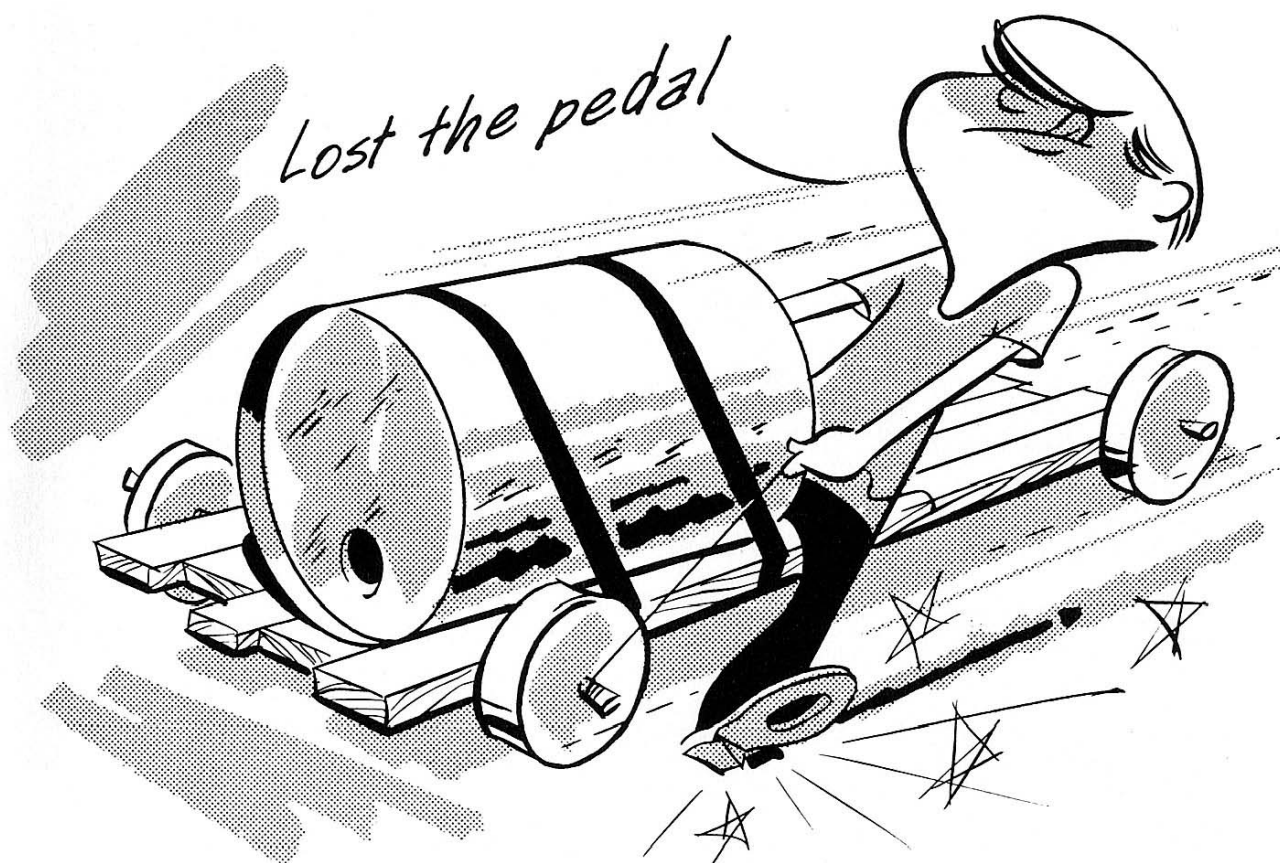

If brake shoe return is slow, be sure to check the return spring tension. Attach a spring scale to the toe of the shoe. Pull the shoe away from the wheel cylinder push rod, and pull it as closely as possible in the direction of piston travel. It should take 35 to 45 pounds for the shoe to break contact with the piston rod.

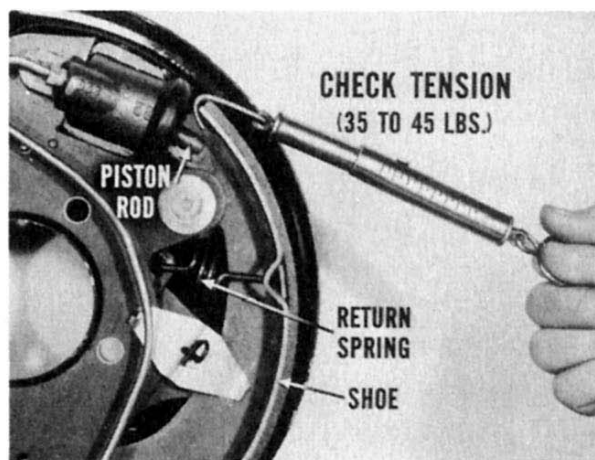

If you don't get that tension reading, try a new spring and recheck tension. Springs specified for our cars are as follows:

	PLYMOUTH	DODGE	DE SOTO	CHRYSLER	IMPERIAL
Front	3 Coil	3 Coil	4 Coil	4 Coil	4 Coil
Rear	6 Coil	6 Coil	5 Coil	5 Coil	5 Coil

If a new return spring doesn't correct the tension reading, the link to which the spring attaches is probably damaged or out of position. At the anchor, the link should go around the rivet and be retained by a dimple in the support plate. If it is not in this position, replace the support plate assembly. The link cannot be serviced separately.

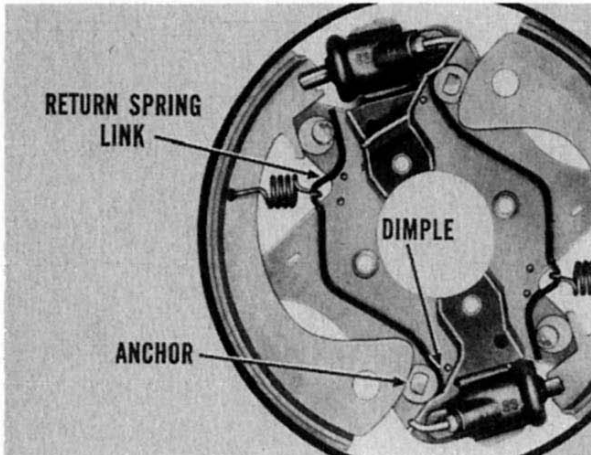

The attaching return link, by the way, provides a *compensating spring effect* along with the return spring. It's designed to move whenever the shoe adjusting cam is turned, and therefore helps maintain proper return spring pressure when adjustments are made as a result of normal wear.

Wedge a screwdriver between the support plates. Apply moderate pressure and check for loose anchors. If you find one, remove the support plate. Place one side of the anchor on an anvil so that no force will strike the support plate, and peen the other side of the anchor. You may have to peen both sides of the anchor.

A shoe that binds within the two parts of the support plate won't return fast, of course. To check for binding, push the shoe until the loops are against the dust shield. Then, release the shoe and use a .005" feeler gauge to see if there's clearance between the outer

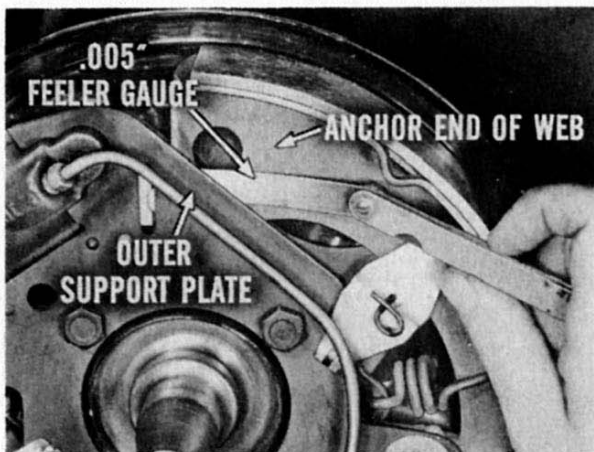

support plate and the anchor end of the web. No clearance means the shoe is binding. Remove the shoe and examine the loop contact pattern on the shield. It should be away from the outer edge and appear light. All other interference should be relieved. Scoring, or galling means loop contact is too heavy.

If the loop is bent, it can rub excessively on the dust shield. Bend the loop to bring it flush with the table edge, and file off any burrs.

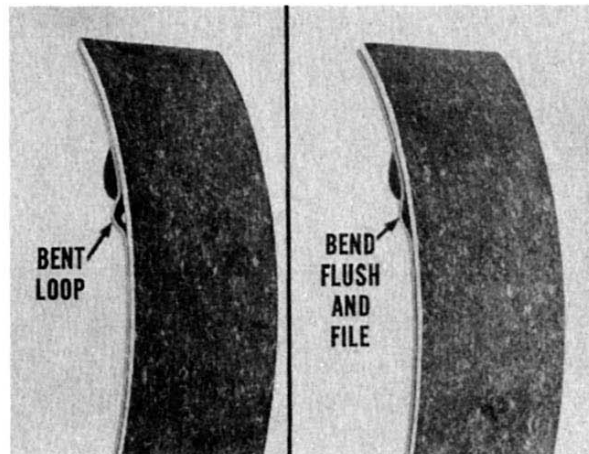

Measure the shoe web to see that it is centered on the table of the shoe. If the web is more than $\frac{1}{16}$ " off center, you'd better replace the shoe assembly.

Another thing . . . the lining must not overlap the edge of the shoe. If it does, file or grind off the overhang.

Once in a while, wheels from one car might be exchanged for wheels from a different series or model. These wheels do not always fit the other drums properly. The bolt circle may fit, but the upset metal around the bolt hole, or the ribs on the brake drum around the studs may not match. What happens? When the wheel bolts are tightened, the drum may be damaged. This affects brake action and may produce noise in the form of a chatter on brake application. Look for mismatched wheels and drums, then, whenever the owner reports a brake chatter or grabbing condition.

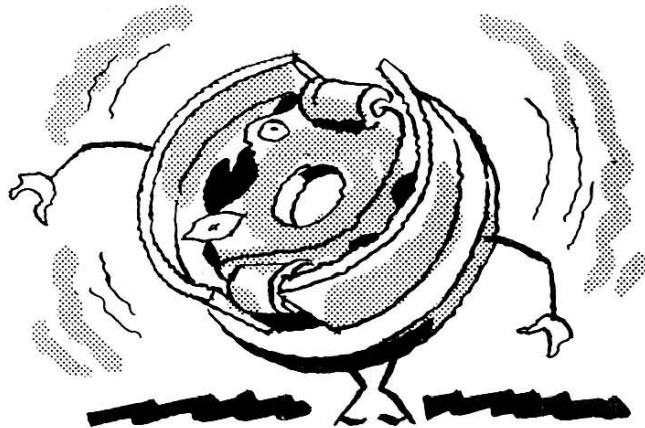

Eccentric drums, as you know, can also cause brake pull, grab, or chatter. Since wheels and drums are off when you check for brake drag and shoe returnability, it would be smart to check for drum eccentricity if you have reason to suspect the drums of being out-of-round.

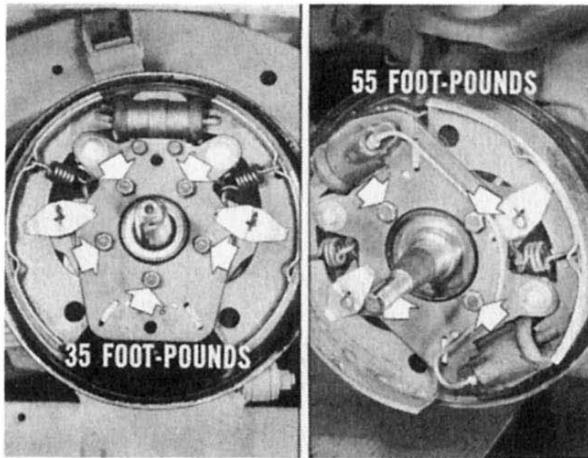

Causes of Noise. Brake noise stems from vibration. So, make sure there is a 35-foot-pounds torque on the bolts which hold the brake support plate to the rear axle housing. On front brakes, there should be 55 foot-pounds torque on the bolts which hold the brake support plate to the steering knuckle.

If there's a *squeak* at the *end of the stop*, install the rod, spring and retainer from the Wheel Brake Dampener Package (Part No. 1879511), at the heel of each brake shoe. Here's how it's done. Remove the wheel and brake drum, and center the shoes on the shield. Scribe a line on the web along the edge of the support plate. Place the retainer $\frac{1}{8}$ " from the edge of the hole in the shoe, and $\frac{1}{8}$ "

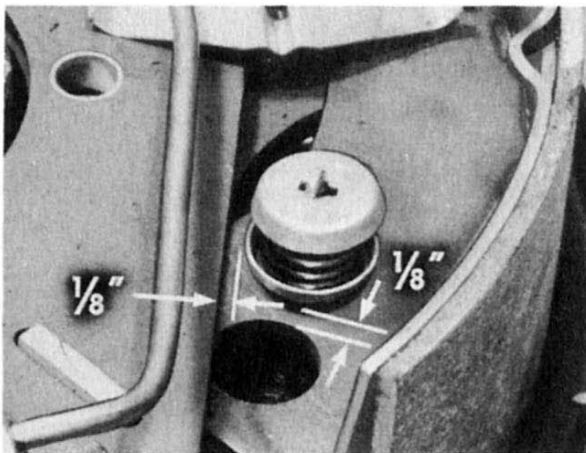

from the scribed reference line. Mark the center of the retainer on the shoe web, and centerpunch the mark. Realign the shoe according to the scribed line. Then, drill a $\frac{1}{4}$ " hole through the web and shield at the punch mark. Remove any burrs. Insert the rod, and then install the retainer and spring. Finally, be sure the shoe loops contact the shield platform, and the shoe is squarely in line with the drum.

When you install the drum, be sure to check tightness of the brake drum dampener springs. Replace any you find loose.



ADJUSTING POWER BRAKES

Power brakes have two main adjustments: pedal free-play, and trigger arm adjustments. Free-play determines how far the pedal will travel before the master cylinder piston applies pressure to the brake fluid. The trigger adjustment, which must be made *after* free-play is adjusted, determines how soon power assist goes into action. Both adjustments are important, and must be made carefully to insure proper power brake performance.

Free-Play. Make this adjustment with no vacuum in the power unit. Turn the ignition off and apply the brake several times to relieve all vacuum. Then, wedge a screwdriver between the power brake pivot and lever hole to eliminate relative motion between these levers. Otherwise, a false free-play setting will register at the pad end of the pedal. Free-play, again, should be $\frac{1}{32}$ " to $\frac{1}{8}$ " with $\frac{1}{16}$ " preferred.

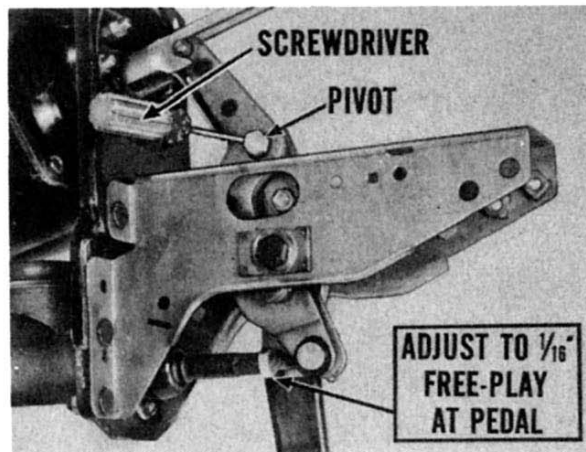

Trigger Adjustment (on car).

Once free-play is adjusted, check booster action. If brake action is hard (pedal applies brakes before power assist), moving the brake pedal adjusting screw *counterclockwise slightly* will speed up booster assist. A *slight clockwise* rotation of the screw will correct a slow booster release.

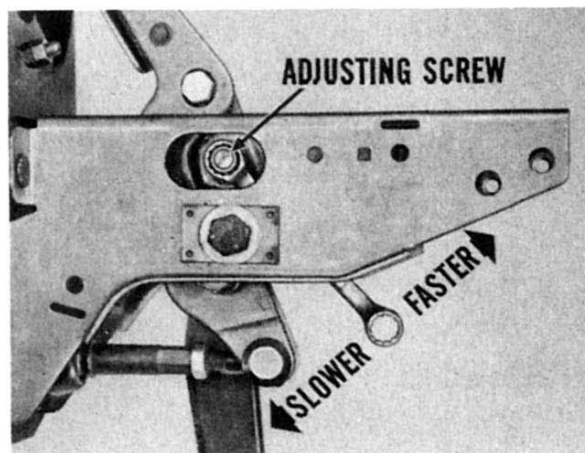

Sometimes slow booster release may cause pedal vibration when pedal pressure is relaxed.

Trigger Adjustment (on bench). If you are unable to get proper trigger adjustment on the car, or if the pedal assembly has been removed from the car, you'll have to perform the following bench operation.

1. Install gauge (C-3508) on the power lever cross pin so the centerline of the gauge falls along the centerline of the lever.
2. Wedge a screwdriver between the power brake and brake pedal levers to remove all free-play. Power brake pedal pivot should rest against the rear side of the elongated hole in the power brake lever, showing that the adjusting screw collar is completely compressed.
3. The outer curved surface of the trigger arm must conform with the inner circle scribed on the gauge. If not, turn the power brake adjusting screw until it does. Tighten the adjusting screw nut when you get proper trigger alignment.

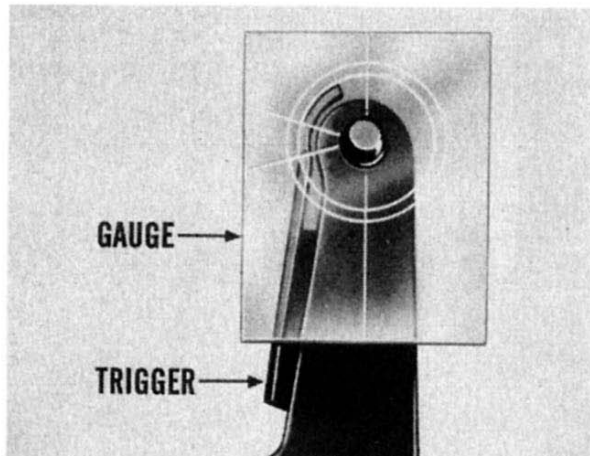

4. Remove the screwdriver, relaxing the two levers. Outer surface of the trigger must conform with the outer circle scribed on the gauge. This conformation is critical only for the distance of the arc described by the two radial lines on the gauge. If the trigger arm still falls short of this requirement, use pliers to bend it carefully until it does conform.

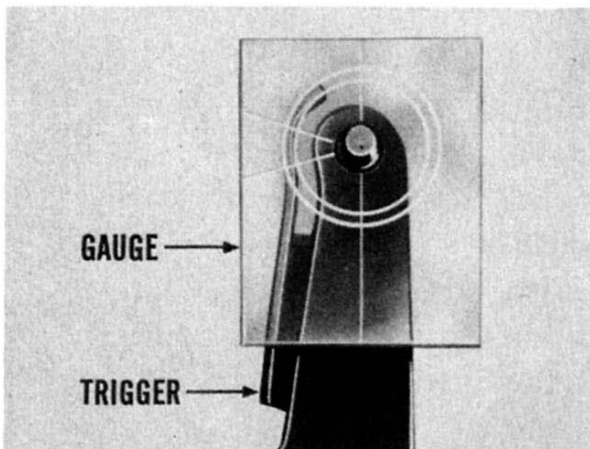

Power Booster Air Noise. Audible air noise is normal on all power brakes during application. Sometimes a noise or hiss continues after the brake is fully applied. On De Soto and Dodge cars having the metal vacuum power unit, this noise is apt to be caused by a slight vacuum leak at the piston rod seal. A leak at this point, usually heard in cold weather when the seal is stiff, doesn't affect power brake operation.

A new rubber diaphragm-type seal is now available as a replacement for the leather piston rod seal and diaphragm gasket. This virtually eliminates the hissing noise and can be installed on early production cars.



FOR SAFETY'S SAKE, REMEMBER THIS . . .

Owners know that their safety (and that of their passengers) depends upon how well the brakes operate. It is no wonder, therefore, that they insist on having brake work done by technicians who have the "know-how" to do the job right. So, give brake service the best you've got in skill, and in materials. That's the surest way to build owner confidence in the quality of your service work.

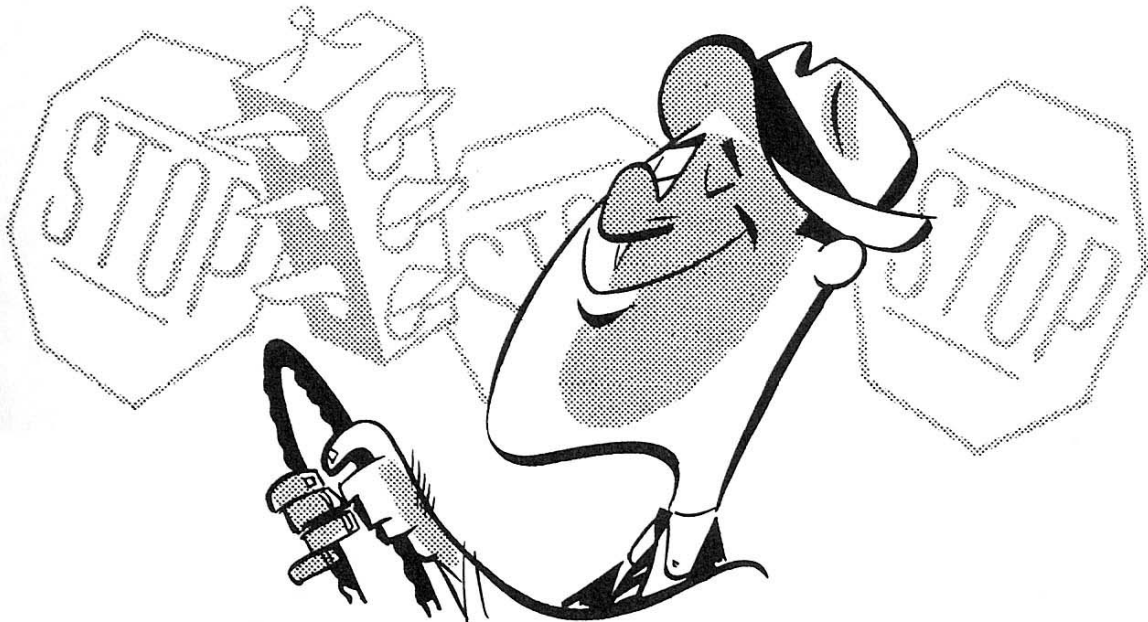

**RECORD YOUR ANSWERS
TO THESE QUESTIONS
ON QUESTIONNAIRE NO. 125**

A car that pulls to the left may not have too much braking effort on the left side; it could have too little braking effort on the right side. RIGHT 1 WRONG

Any car that has a tendency to run to one side during normal driving, and pulls in the same direction when brakes are applied, probably has an alignment rather than a brake condition. RIGHT 2 WRONG

Brake lining fade is due to a loss of friction between the lining and drum because of too much heat. RIGHT 3 WRONG

Increased pedal travel can be caused by too much shoe clearance, low fluid level, improper fluid, air in the system, or a leaking master cylinder check valve. RIGHT 4 WRONG

Uneven friction, due to less than full lining contact at one wheel, can cause the car to pull to the opposite side. RIGHT 5 WRONG

Excessive looseness in the front-end suspension, or steering linkage can cause brake pull. RIGHT 6 WRONG

Caster on the front wheels should be negative on the right, and positive on the left. RIGHT 7 WRONG

Pedal free-play on power brakes should be $\frac{1}{32}$ " to $\frac{1}{8}$ ", $\frac{1}{16}$ " preferred. RIGHT 8 WRONG

Standard brake pedals should have $\frac{1}{8}$ " to $\frac{1}{4}$ " free-play, $\frac{1}{8}$ " preferred. RIGHT 9 WRONG

On front brakes, support plate to steering knuckle bolts should be torqued to 55 foot-pounds. RIGHT 10 WRONG

Litho in U.S.A.